

version .0

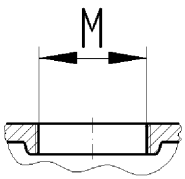

version .1

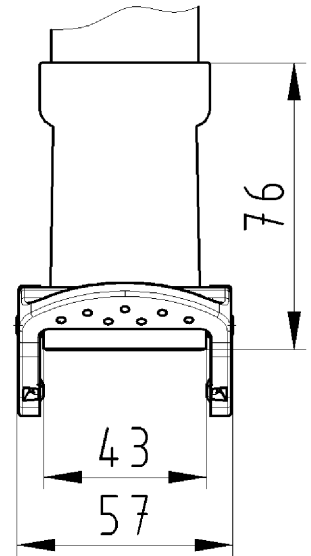
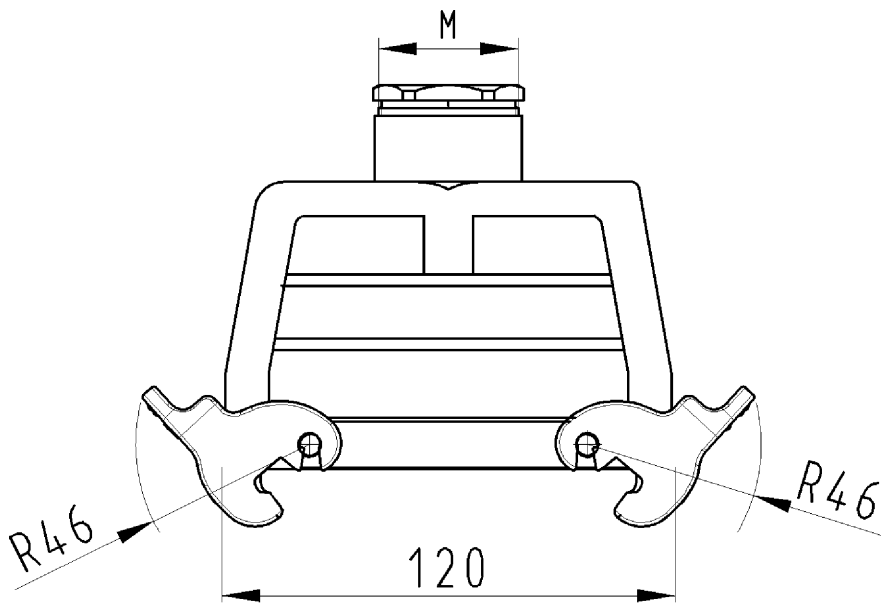
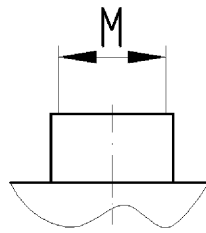

version .2

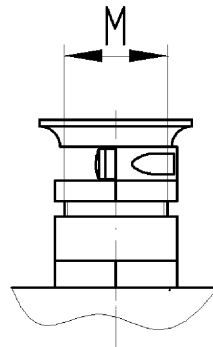

version .3

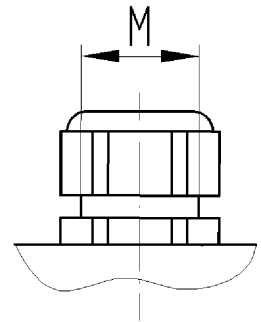

version .5

IP 65

Gehäuseoberteil
73.357.6435.0

Zeichnungsnummer
73.357.6435.010W
Gehäuseoberteil

03.01.2008
Hoffmann Angelika
M 1:2